

A tall, silver metal aeration windmill stands in a grassy field. It has a lattice tower with four levels and a large, multi-bladed windmill head at the top. The background shows a line of trees under a clear sky.

***Outdoor Water Solutions  
Aeration Windmill  
Installation Manual***

**Outdoor Water Solutions, Inc.**

Springdale, AR 72764 • 1-866-471-1614 (Toll Free) • 1-479-756-1614  
[www.outdoorwatersolutions.com](http://www.outdoorwatersolutions.com)

## Outdoor Water Solutions Accessories

### Tower Hinges

A set of Outdoor Water Solutions Tower Hinges are a great way to make raising and lowering your windmill more safe and easy. Simple to install, they allow the windmill to pivot on two points, making the base much more stable.



### Weighted Air Line

Weighted Air Line can be used in the pond to keep your air line on the bottom. This allows easier fishing, boating, swimming, etc., and also keeps your air line from freezing on the surface in climates where ice is a possibility. Available in 50', 100', and 500' lengths.



### Freeze Control System

An Outdoor Water Solutions Freeze Control System keeps your air line from freezing in the winter due to excess condensation in the line. A Freeze Control System is **HIGHLY RECOMMENDED** and will keep your warranty intact if freezing temperatures are common in the winter months.



### 2-Way Valves

These high-quality valves allow you to adjust airflow between multiple airstones.

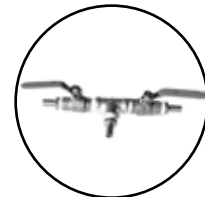

### Airstone Housing Bucket

These high-quality buckets are ideal for protecting the airstone from the mud and debris common in most ponds and lakes.



### Airstone Marker – Duck Decoy

The use of a duck decoy allows you to mark the airstone and can also serve as a way to lift your Airstone Housing Bucket (if needed) to move or service.



### OWS Small Pond Accessory Kit

- Includes everything you need to aerate a 1/8-acre to 1-acre pond
- Includes tower hinges, which help raise and lower your tower for maintenance
- Includes 50' of weighted air line, so your air line sinks to the bottom of your pond
- Includes 1 airstone housing bucket, 1 duck decoy marker, and hose connectors.



### OWS Medium Pond Accessory Kit

- Includes everything you need to aerate a 1- to 2-acre pond
- Includes tower hinges, which help raise and lower your tower for maintenance
- Includes 150' of weighted air line, so your air line sinks to the bottom of your pond
- Includes 1 extra airstone and foot valve, a 2-way selector valve to regulate oxygen flow, 2 airstone housing buckets, 2 duck decoys, and hose connectors.



## The Outdoor Water Solutions 3/5-Year Limited Warranty

This warranty covers all Outdoor Water Solutions, Inc. Windmill products for 3 years from purchase date against defects in workmanship and 5 years from purchase date against defects in the compressor.

1. Outdoor Water Solutions, Inc. (OWS) will replace or repair any part deemed to be defective by Outdoor Water Solutions, Inc., due to defects in quality and/or workmanship within a 3-year period from the initial date of purchase. Functional windmill compressors are covered for 5 years from date of purchase against major defects. Note: Diaphragm and check valve replacement are considered routine maintenance, if needed.
2. Warranty does not apply to OWS products that are installed incorrectly, subject to an accident, neglect, or damage due to excess winds.
3. This warranty does not apply to damage caused by severe weather. Private insurance coverage is recommended.
4. When an OWS Freeze Control System has not been used, warranty coverage may not apply to damages incurred to an Outdoor Water Solutions Aeration System as a result of a blocked line. The use of an Outdoor Water Solutions Freeze Control System or an inline Pressure Relief Valve is HIGHLY RECOMMENDED in geographical areas where freeze may be a concern in order to keep excess back pressure off of the compressor.
5. Product returned for warranty repair must be returned to the address specified by the Manufacturer, and any warranty product sent to the customer will be sent freight prepaid.
6. Warranty coverage may be void if parts other than genuine Outdoor Water Solutions parts are utilized for repair or attached to an Outdoor Water Solutions Aeration System.
7. Proof of purchase date is required for warranty repairs.
8. If you have any warranty concerns, please contact Outdoor Water Solutions, Inc. at 1-866-471-1614 in Canada or the U.S.A. International customers can call 1-866-471-1614 or 1-479-756-1614 with any warranty concerns.

### Safety Precautions

1. DO NOT attempt any service or repairs to the windmill in a high-wind situation.
2. Make sure the blades are secured when service or repair is necessary for compressor. We recommend laying the windmill down while working on it vs. trying to do repairs while it is standing. A sudden gust of wind can physically turn the rotor head, causing possible injury.
3. DO NOT get near the windmill in high-wind situations or in a thunderstorm.
4. DO NOT allow children to play on or near the windmill.

### Return Materials Authorization

- A return materials authorization (RMA) number must be obtained prior to returning any product for warranty work.
- You can call the Outdoor Water Solutions warranty department at the following numbers:
  - Canada and the U.S. – 1-866-471-1614
  - International (outside Canada and the U.S.) – 1-866-471-1614 or 1-479-756-1614

Outdoor Water Solutions, Inc. recommends that, for future reference, you keep this Installation Manual in a convenient location.

Date of Purchase: \_\_\_\_\_



## TABLE OF CONTENTS

Title	Steps	Page(s)
The Outdoor Water Solutions 3- to 5-Year Limited Warranty	—	2
Tips & Suggestions – Installing Outdoor Water Solutions Aeration Windmill	—	3
Contents of the Aeration Windmill Boxes	—	4 – 6
Outdoor Water Solutions Windmill Tower Assembly	1 – 8	7 – 11
Blade Assembly	9 – 10	12 – 13
Tail & Pivot Tube Installation	11 – 12	13 – 14
Final Set Up	13	15 – 17

### Tips and Suggestions for Installing an Outdoor Water Solutions Aeration Windmill

- WE STRONGLY RECOMMEND THAT YOU READ THROUGH THIS ENTIRE MANUAL BEFORE BEGINNING ASSEMBLY. IF YOU HAVE ANY QUESTIONS, PLEASE CONTACT US AT (866) 471-1614.
- In order for your windmill to work properly, YOU MUST LOCATE THE AREA WITH THE MOST WIND EXPOSURE NEAR YOUR POND. The windmill can be positioned up to 1,000 feet away from the pond.
- Anchoring of the windmill tower is very important. Outdoor Water Solutions, Inc. (OWS) supplies a BASIC anchoring kit with each unit. We STRONGLY recommend an anchoring system such as concrete pilings, a concrete pad, or screw-in anchors. High winds or light soil conditions can cause the windmill to fall over, physically damaging the rotor head and other components. The customer is responsible to anchor the Windmill adequately or consult the appropriate people to do so.
- NOTE: DURING THE TOWER ASSEMBLY, DO NOT COMPLETELY TIGHTEN ANY NUTS OR BOLTS UNTIL THE TOWER IS COMPLETED, UNLESS SPECIFICALLY DIRECTED OTHERWISE.
- NOTE: DO NOT TIGHTEN ANY OF THE BLADES ON THE HUB UNTIL THE BLADE BRACES HAVE BEEN INSTALLED.
- NOTE: HUB MUST FACE DOWN WHEN THE BLADES AND BLADE BRACES ARE BEING INSTALLED (FACE DOWN MEANS THE SMALLER BOLT HOLE IN THE FRONT MUST BE FACING DOWN. THE EXPOSED 1” HOLE FOR THE SHAFT SHOULD FACE UP). THIS ALLOWS THE PROPER BLADE PITCH, SLIGHTLY FORWARD, WHEN COMPLETE. IT IS ALSO HELPFUL TO SET THE BLACK HUB UP ON A TIRE, BUCKET, OR BOX WHEN INSTALLING THE BLADES AND BLADE BRACES. THIS ALLOWS EVERYTHING TO PITCH FORWARD VS. BACKWARDS.
- NOTE: IN COLD CLIMATE AREAS, WHERE FREEZING DOES OCCUR, WE RECOMMEND THE USE OF AN OWS FREEZE CONTROL SYSTEM TO AID IN KEEPING THE AIR LINE OPEN. CONDENSATION CAN FORM IN THE AIR LINE AND RESTRICT AIR FLOW, PUTTING UNDUE PRESSURE ON THE PUMPING MECHANISM AND VOIDING THE WARRANTY.
- We also recommend the use of Outdoor Water Solutions Tower Hinges as an accessory, allowing ease in lowering and raising the tower.





## Contents of Outdoor Water Solutions Aeration Windmill Boxes

Note: Make sure all components and accessories are accounted for before beginning assembly.

ITEM CODE	DESCRIPTION (Nut & Bolt Quantities are for a 20' tower)	PACKAGED IN	TOTAL QUANTITY IN COMPLETE				DIAGRAM (not to scale)
			12' Tower	16' Tower	20' Tower	24' Tower	
BLA	Blade	Blade & Tail Box	12	12	12	12	
BBR	Blade Brace	Blade & Tail Box	12	12	12	12	
HUB	Blade Hub Assembly	Hub & Dome Box	1	1	1	1	
DOME	Dome	Hub & Dome Box	1	1	1	1	
COMP	Windmill Compressor	Compressor Box	1	1	1	1	
GRS	Ground Rod Stakes	8' Tower Box	3	3	3	3	
LTS	Leg Top Section – 14 Holes	8' Tower Box	3	3	3	3	
LEN	Leg Extension – 8 Holes	8', 12', 16', 20', 24'	6	9	12	15	
CM23	22 <sup>3</sup> / <sub>4</sub> " Cross Member	8' & 20' Tower Boxes	3	3	6	6	
CM 32	32" Cross Member	12' Tower Box	6	6	6	6	
CM41	41" Cross Member	8', 12', 16', 20', 24'	3	9	15	24	
PW	Pivot Tube Washer	Package G	1	1	1	1	

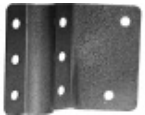
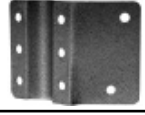
## Contents of Outdoor Water Solutions Aeration Windmill Boxes

**NOTE:** Make sure all components and accessories are accounted for before beginning assembly.



ITEM CODE	DESCRIPTION (Nut & Bolt Quantities are for a 20' tower)	PACKAGED IN	TOTAL QUANTITY IN COMPLETE				DIAGRAM (not to scale)
			12' Tower	16' Tower	20' Tower	24' Tower	
PVT	Pivot Tube	Blade & Tail Box	1	1	1	1	
SCBR	Stake Clamp Bracket-Right	Hardware Box	3	3	3	3	
SCBL	Stake Clamp Bracket-Left	Hardware Box	3	3	3	3	
TAM	Tail Arm – with one bent end		2	2	2	2	
TFN	Tail Fin (2 pieces)	Blade & Tail Box	2	2	2	2	
CONE	Tower Cone	Compressor Box	1	1	1	1	

### Cross Braces

### Tower Box

#1	15 <sup>7</sup> / <sub>8</sub> " Cross Brace	20' Tower Box	0	0	6	6	
#2	19" Cross Brace	8' & 24' Tower Box	6	6	6	12	
#3	27 <sup>1</sup> / <sub>4</sub> " Cross Brace	12' Tower Box	6	6	6	6	
#4	29 <sup>1</sup> / <sub>2</sub> " Cross Brace	8' & 24' Tower Box	3	3	3	9	
#5	33 <sup>3</sup> / <sub>4</sub> " Cross Brace	8', 12', & 20' Tower Box	6	6	9	9	
#6	35 <sup>1</sup> / <sub>4</sub> " Cross Brace	16' Tower Box	0	6	6	6	
#7	38 <sup>1</sup> / <sub>2</sub> " Cross Brace	12', 20', & 24' Tower Box	3	3	6	9	
#8	41" Cross Brace	16' Tower Box	0	3	3	3	
#9	43 <sup>3</sup> / <sub>4</sub> " Cross Brace	20' & 24' Tower Box	0	0	6	9	
#10	45 <sup>1</sup> / <sub>4</sub> " Cross Brace	16' Tower Box	0	3	3	3	
#11	23 <sup>1</sup> / <sub>2</sub> " Cross Brace	24' Tower Box	0	0	0	6	

### Bolt Package Contents

ABK	Angle Bracket – Used to tighten cross braces	Hardware Box	6	9	12	15	
	#10" x 1/2" Sheet Metal Screw – (4) used to attach dome to hub assembly	Package G	4	4	4	4	

## Contents of Outdoor Water Solutions Aeration Windmill Boxes

**Note:** Make sure all components and accessories are accounted for before beginning assembly.

ITEM CODE	DESCRIPTION (Nut & Bolt Quantities are for a 20' tower)	PACKAGED IN	TOTAL QUANTITY IN COMPLETE				DIAGRAM (not to scale)
			12' Tower	16' Tower	20' Tower	24' Tower	
	5/16" x 1/2" Bolts – (18) to connect Cross Braces (12) attach eye bolts to cross braces (4) attach tail arms to compressor (1) to attach hub assembly to shaft	Package A	18	24	36	54	
	5/16" Flange Nuts – Used with 5/16" x 1/2" bolt (2) used to tighten U-bolt to pivot tube	Package B	18	24	36	54	
	1/4" x 1/2" Bolts – (2) to install elongated hose clamp brackets (48) join cross members (24) install blade braces (24) install cone to leg (6) to join the two-piece Tail Fin	Package D	68	80	104	128	
	1/4" x 3/4" Bolts – (60) to attach cross members to leg (18) stake clamp assembly (36) install blades to hub assembly (2) to connect tail arms to tail	Package C	92	104	116	131	
	Eye Bolt – Used to tighten cross braces & tensioners	Package G	6	9	12	15	
	1/4" Nuts – Used with all 1/4" bolts (2) to be used with each eye bolt	Package E	172	202	244	298	
	1/4" Washers – (36) for ground stake clamps (36) for blade to hub assembly	Package F	108	108	108	108	
	1/4" Lock Washers	Package H	160	184	220	259	
	U-Bolts – Used to attach pivot tube to compressor	Package G	1	1	1	1	
	1/2" x 1/2" – 90-degree Hose Barb	Hardware Box	1	1	1	1	
EHB	Elongated Hose Clamp Bracket – (2 pieces)	Hardware Box	1	1	1	1	
	5/32" Allen Wrench – Used to tighten locking collars to shaft	Package G	1	1	1	1	

All hardware for the 24' section is in the 24' Tower Section Box

Illustration 1

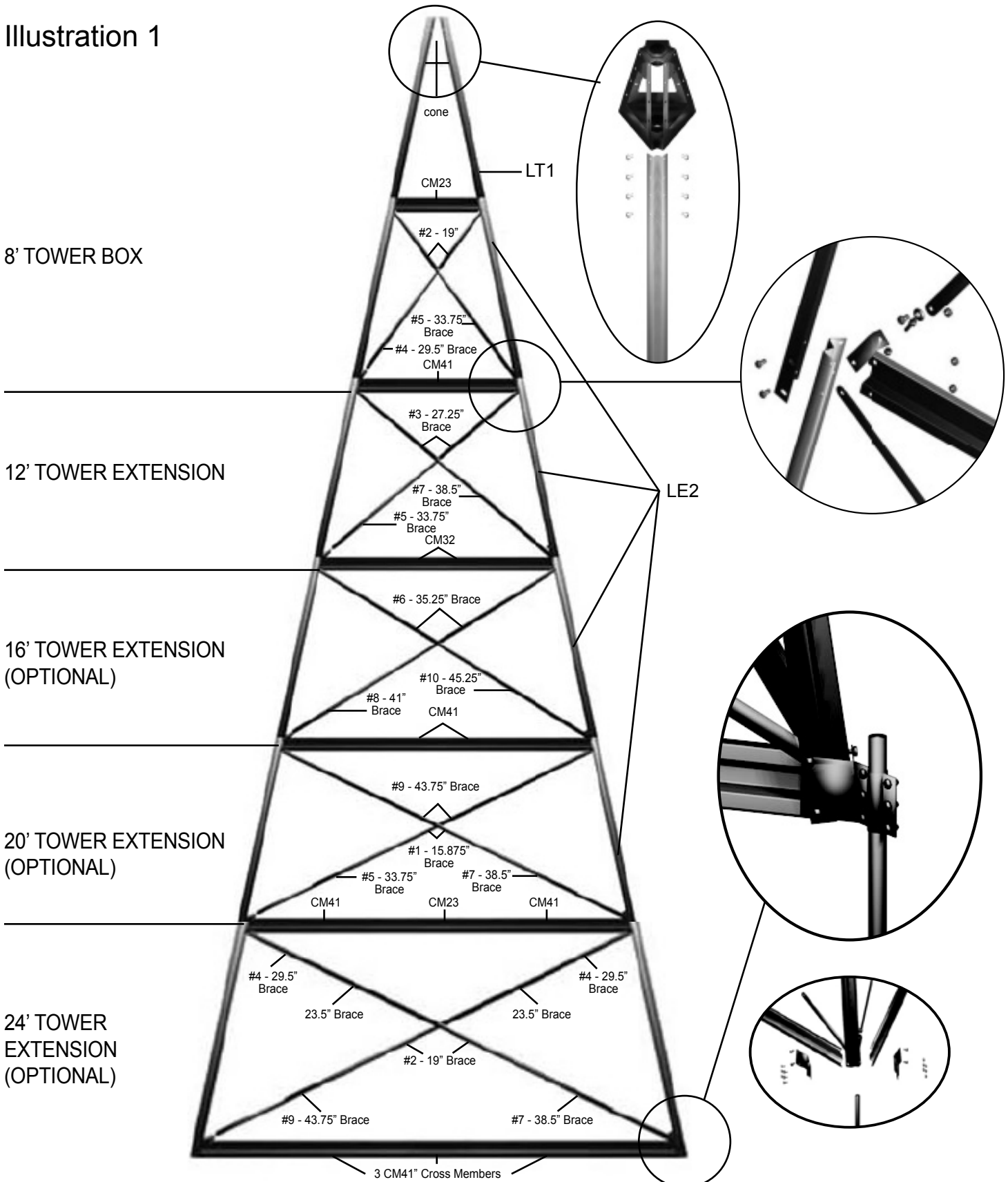
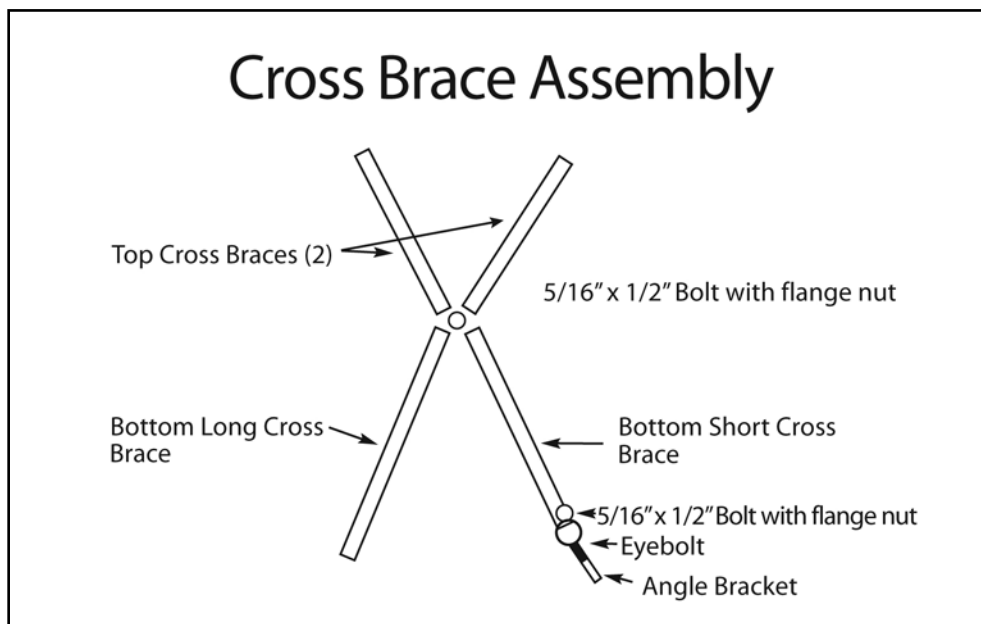



Illustration 2



Inside



Outside

## TOWER ASSEMBLY:

### IMPORTANT TIPS TO EASE TOWER ASSEMBLY:

- We highly recommend that you read through the manual completely before beginning the assembly process. If you have any questions, please contact us at (866) 471-1614.
- It is extremely important that you do not tighten any nuts or bolts during the tower assembly process unless specifically told differently in the instruction manual.

### READ THROUGH ENTIRE MANUAL BEFORE BEGINNING ASSEMBLY

### TOOLS REQUIRED FOR ASSEMBLY:

- (2) ½" Wrenches or socket drivers
- (2) 7/16" Wrenches or socket drivers
- ¾" Wrench or socket driver
- Needle-nose vice grip

NOTE: We are now providing a lock washer for every ¼" bolt. This is an optional item, but can help keep all bolts and nuts tight over time. Install (1) behind each ¼" nut used in the assembly process for both the tower and windmill head. (They are not needed for the cross-brace tighteners.)

### STEP 1 — TOP 4' SECTION:

1. Using the (24) ¼" x ½" bolts (package D) and (24) ¼" nuts (package E) to attach the three top legs (LTS) to the cone (cone) as shown in Illustration 1. Tighten the nuts and bolts completely.
2. Using (1) ¼" x ½" bolt and (1) ¼" nut, attach the elongated hose bracket (EHB in package H) to any one of the three top legs (LTS), using the hole in the top leg (LTS) that is just below the tower top. Tighten completely. Using another ¼" x ½" bolt and (1) ¼" nut, attach the air line clamp to the elongated hose bracket. Do not tighten until you place the air line into the bracket during the final stage of assembly (once head has been attached).

From this point forward, complete tower laying on one side on a level surface. A couple of tables or picnic tables are helpful. If assembling on a rough surface, use a drop cloth or cardboard to protect the finish (especially if powder coated).

3. It is important that you only install the ¼" x ¾" bolts only in the top hole, where the 4' and 8' section overlap. Do not install the bottom bolts at this step. You should now install the cross member (CM23): Please refer to Illustration 1 on page 7.

NOTE: Make sure that the order shown in Illustration 1 is followed. The correct order for each connection is to have the upper leg section first, lower section leg second, cross brace or angle bracket third, then the cross member. Install the angle brackets on the same side throughout the tower and ensure that they are turned inward.

4. Repeat for all three sides.

### STEP 2 — 4'– 8' SECTION:

1. Using the ¼" x ¾" bolts at the 4' leg sections overlap (where LT1 and LE2 come together), install #2 cross braces between the 4' leg section and the cross member (CM23). To finish the "X" cross braces, use one 5/16" x ½" bolt and one 5/16" flange nut for the cross brace connection, attaching the #4 and #5 cross braces to the #2 cross braces.
2. The eye bolt should be installed on the #4 cross brace forming the bottom of the "X". To install the eye bolt, insert one 5/16" x ½" bolt through the eye bolt, then through the hole in the end of the #4 cross brace (as shown in Illustration 1). Secure the eye bolt with one 5/16" flange nut.
3. Install one ¼" nut onto each eye bolt and turn it until it reaches the top of the threaded section of the eye bolt.

Refer to Illustration 1 for direction.

4. Install the short end of the angle bracket (ABK) onto each of the eye bolts, using one  $\frac{1}{4}$ " nut (as shown in Illustration 1). The nut on the bottom of the eye bolt should be installed just far enough to ensure that it will not fall off.
5. Using the top  $\frac{1}{4}$ " x  $\frac{3}{4}$ " bolts at the 8' leg overlap, install the 8'– 12' section extension legs (LEN), the #5 cross brace on one side, the angle bracket (ABK) (turned inward) on the opposite side attached to the #4 cross brace and the cross member (CM41). Refer to Illustration 1 for direction. Also see Illustration 2 to see how the finished corner should appear.
6. Repeat for all three sides.

#### STEP 3 — 8'– 12' SECTION:

1. Using the  $\frac{1}{4}$ " x  $\frac{3}{4}$ " bolts at the 8' leg sections overlap (where LE2 and LE2 come together), install #3 cross braces between the 8' leg section and the cross member (CM41). To finish the "X" cross braces, use one  $\frac{5}{16}$ " x  $\frac{1}{2}$ " bolt and one  $\frac{5}{16}$ " flange nut for the cross brace connection attaching the #5 and #7 cross braces to the #3 cross braces. Refer to Illustration 1 for direction.
2. The eye bolt should be installed on the #5 cross brace forming the bottom of the "X". To install the eye bolt, insert one  $\frac{5}{16}$ " x  $\frac{1}{2}$ " through the eye of the eye bolt, then through the hole in the end of the #5 cross brace (as shown in Illustration 1). Secure the eye bolt with one  $\frac{5}{16}$ " flange nut.
3. Install one  $\frac{1}{4}$ " nut onto each eye bolt and turn until it reaches the top of the threaded section of the eye bolt. Refer to Illustration 1 for direction.
4. Install the short end of one angle bracket (ABK) onto each of the eye bolts using  $\frac{1}{4}$ " nut (as shown in Illustration 1). The nut on the bottom of the eye bolt should be installed just far enough to ensure that it will not fall off.
5. For each of the three sides of the tower, assemble the 12' cross member assembly by attaching two CM32s together using four  $\frac{1}{4}$ " and  $\frac{1}{2}$ " bolts and tighten completely.
6. If you are assembling a 12' tower, go to Step 6 for the tower base installation instructions.
7. If you are assembling a 16' or 20' tower: using the top  $\frac{1}{4}$ " x  $\frac{3}{4}$ " bolts at the 12' leg overlap, install the 12'–16' section extension legs (LE2), place the #7 cross brace on one side, the #5 cross with the angle bracket (ABK) (turned inward) on the opposite side, and the CM32 cross assembly assembled in No. 5 above. Refer to Illustration 1 for direction. Also see Illustration 2 to see how the finished corner should appear.
8. Repeat steps for all three sides.

#### STEP 4 — 12'– 16' SECTION:

1. Using the  $\frac{1}{4}$ " x  $\frac{3}{4}$ " bolts at the 12' leg sections overlap (where LE2 and LE2 come together), install #6 cross braces between the 12' leg section and the cross member (the two CM32 cross members assembled above). To finish the "X" cross braces, use one  $\frac{5}{16}$ " x  $\frac{1}{2}$ " bolt and one  $\frac{5}{16}$ " flange nut for the cross brace connection attaching the #8 and #10 cross braces to the #6 cross braces. Refer to Illustration 1 for direction.
2. The eye bolt should be installed on the #8 cross brace forming the bottom of the "X". To install the eye bolt, insert one  $\frac{5}{16}$ " x  $\frac{1}{2}$ " bolt through the eye of the eye bolt, then through the hole in the end of the #8 cross brace (as shown in Illustration 1). Secure the eye bolt with one  $\frac{5}{16}$ " flange nut, leaving it loose so that the eye bolt can rotate.

3. Install one  $\frac{1}{4}$ " nut onto each eye bolt and turn it until it reaches the top of the threaded section of the eye bolt. Refer to Illustration 1 for direction.
4. Install the short end of one angle bracket (ABK) onto each of the eye bolts using one  $\frac{1}{4}$ " nut (as shown in Illustration 1). The nut on the bottom of the eye bolt should be installed just far enough to ensure that it will not fall off.
5. For each of the three sides of the tower, assemble the 16' cross member assembly (CM41, CM41) using four  $\frac{1}{4}$ " and  $\frac{1}{2}$ " bolts and tighten completely.
6. If you are assembling a 16' tower: go to Step 6 for the tower base installation instructions.
7. If you are assembling a 20' windmill: Using the top  $\frac{1}{4}$ " x  $\frac{3}{4}$ " bolts at the 16' leg overlap, install the 16'–20' section extension legs (LEN), the #10 cross brace on one side, the #8 cross brace with the angle bracket (ABK) (turned inward) on the opposite side, and the CM41 cross member assembly in Step 5. Refer to Illustration 1 for direction. Also see Illustration 2 to see how the finished corner should appear.
8. Repeat steps for all three sides.

#### STEP 5 — 16'– 20' SECTION:

1. Using the  $\frac{1}{4}$ " x  $\frac{3}{4}$ " bolts at the 16' leg overlap (where LE2 and LE2 come together), install #9 cross braces between the 16' leg section and the cross member (the two CM41 cross members assembled above). To finish the "X" cross braces, use one  $\frac{5}{16}$ " x  $\frac{1}{2}$ " bolt and one  $\frac{5}{16}$ " flange nut for the cross brace connection attaching the #1 cross braces to the #9 cross braces. Then attach #5 and #7 cross braces to the #1 cross braces, using one  $\frac{5}{16}$ " x  $\frac{1}{2}$ " bolt and one  $\frac{5}{16}$ " flange nut. Refer to Illustration 1 for direction.
  2. The eye bolt should be installed on the #5 cross brace forming the bottom of the "X". To install the eye bolt, insert one  $\frac{5}{16}$ " x  $\frac{1}{2}$ " bolt through the eye of the eye bolt, then through the hole in the end of the #5 cross brace (as shown in Illustration 1). Secure the eye bolt with one  $\frac{5}{16}$ " flange nut, leaving it loose so that the eye bolt can rotate.
  3. Install one  $\frac{1}{4}$ " nut onto each eye bolt and turn it until it reaches the top of the threaded section of the eye bolt. Refer to Illustration 1 for direction.
  4. Install the short end of one angle bracket (ABK) onto each of the eye bolts, using one  $\frac{1}{4}$ " nut, as shown in Illustration 1. The nut on the bottom of the eye bolt should be installed just far enough to ensure that it will not fall off.
  5. For each of the three sides of the tower, assemble the 20' cross member assembly (CM41, CM23, CM41) using eight  $\frac{1}{4}$ " x  $\frac{1}{2}$ " bolts and tighten completely.
  6. Repeat steps for all three sides.
- 20'– 24' Section: Repeat the steps above for all other sections using the cross braces and cross members shown in Illustration 1 for the 24' Tower Extension.

## STEP 6 — TOWER BASE:

1. Separate stake clamps (SCBR, SCBL) into 3 sets of one left and one right per set.
2. Install one stake clamp set and the 12', 16', 20', or 24' cross member assembly (depending on your tower size) to the leg bottom. Use only the bottom  $\frac{1}{4}$ " x  $\frac{3}{4}$ " bolt. Refer to Illustration 1 for directions. Repeat for each side.
3. Insert a  $\frac{1}{4}$ " x  $\frac{3}{4}$ " bolt through the top of the ground stake clamp, tower leg, cross brace or angle bracket, and cross member. Refer to Illustrations 1 and 2 for directions. Repeat for each side.
4. Install the six  $\frac{1}{4}$ " x  $\frac{3}{4}$ " bolts, 12 washers, and six nuts on each set of stake clamps (as shown in Illustration 1). Do not tighten these bolts until the ground rod stakes (GRS) are installed.

## STEP 7 — TIGHTEN BOLTS:

1. Starting at the top 4'– 8' section, tighten all bolts and nuts attaching the CM23 cross members to the tower legs.
2. Tighten the center bolt of each cross brace in the 4'– 8' section.
3. Adjust all three cross brace tensioners (angle bracket and eye bolts) until cross braces are tight. Do not overtighten, as overtightening will straighten the angle bracket. Tighten all nuts so that the cross brace tensioner is locked into place.
4. Repeat for the remaining tower sections. It is critical that you tighten each section completely before moving to the next-lower section of the tower. Do not tighten the six  $\frac{1}{4}$ " x  $\frac{3}{4}$ " bolts in the stake clamps at this time.

## HEAD ASSEMBLY:

### STEP 8 — BLADE INSTALLATION:

Note: Do not tighten any of the blades on the hub until the blade braces have been installed.

Note: Hub must face down when blades and blade braces are being installed ('face down' means the smaller bolt hole in the front must be facing down. The exposed 1" hole for the shaft should face up). This allows the proper blade pitch—slightly forward—when complete.

1. Install all twelve blades (BLA), as shown in Illustration 3. Make sure the bolts and washers go through the 3 holes in the blade, with the nuts attached on the inside of the hub. DO NOT finger-tighten — keep VERY LOOSE!

Illustration 3  
 $\frac{1}{4}$ " x  $\frac{3}{4}$ " BOLTS & NUTS  
(Package C)



## STEP 9 — BLADE INSTALLATION:

Illustration 4

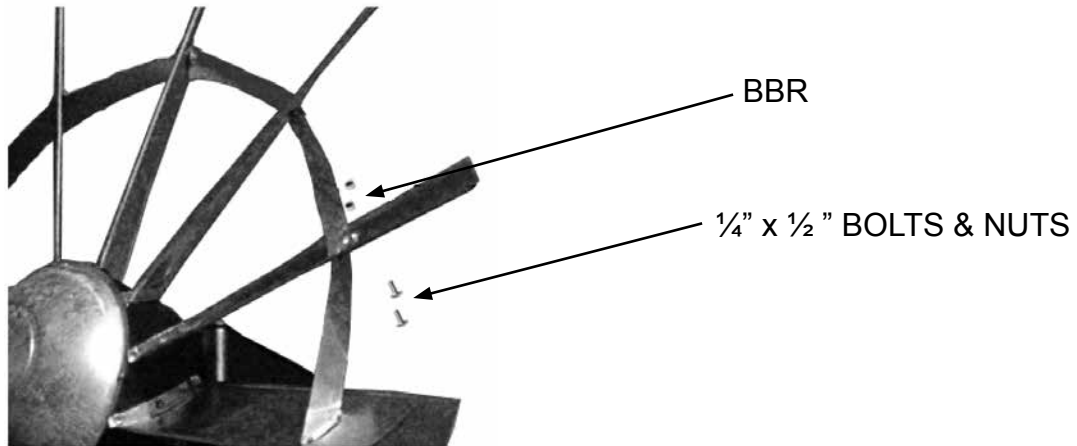

1. Install all twelve blade braces (BBR), as shown in Illustration 4 above. Keep all nuts very loose until AFTER the last blade brace has been installed. Again, it will help if the hub is elevated up on a tire or bucket, allowing the blades to fall downwards, giving us a forward pitch. **MAKE SURE** the small hole in the hub is on the bottom and the 1" hole is on top!
2. After ALL of the blades and blade braces have been installed, you can flip the windmill head over onto the other side (small hole on top). This makes it easier to reach the bolt heads on the blades for tightening. Completely tighten all bolts on both the blades and blade braces. A small impact driver or impact wrench with a deep socket placed inside the hub along with an open ended wrench on the outside can speed tightening of all bolts.

## STEP 10 — TAIL PRE-ASSEMBLY:

Illustration 5

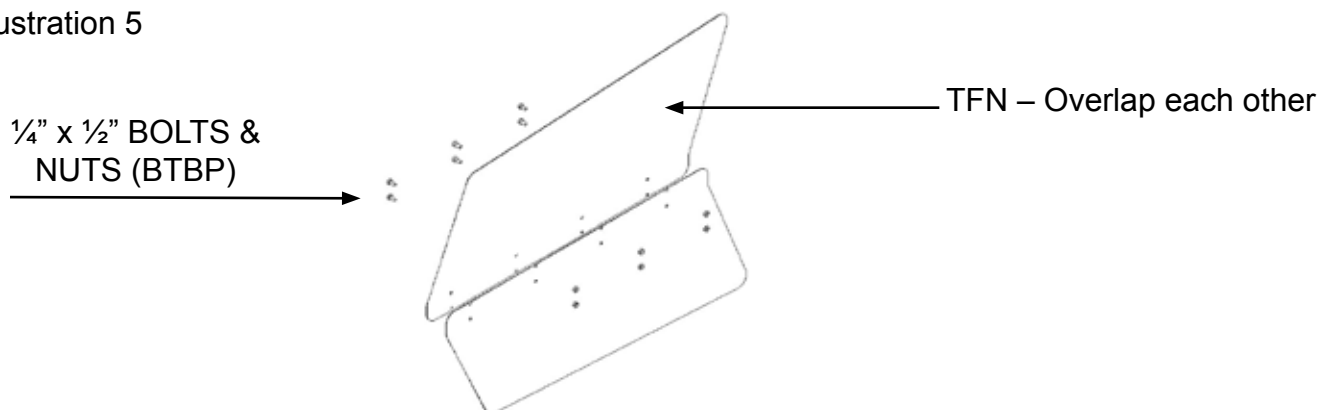

1. Pre-assemble tail fins (TFN) for Step 10. Overlap each tail fin by lining up the bolt holes in the channel of both. Insert  $\frac{1}{4}$ " x  $\frac{1}{2}$ " bolts & nuts in the back six bolt holes and tighten (see Illustration 5).
2. Attach tail arms to tail fin in the front two bolt holes using  $\frac{1}{4}$ " x  $\frac{3}{4}$ " bolts and  $\frac{1}{4}$ " nuts (as shown in Illustration 6 on the next page). Tighten when tail arm and tail fin are straight.

Illustration 6

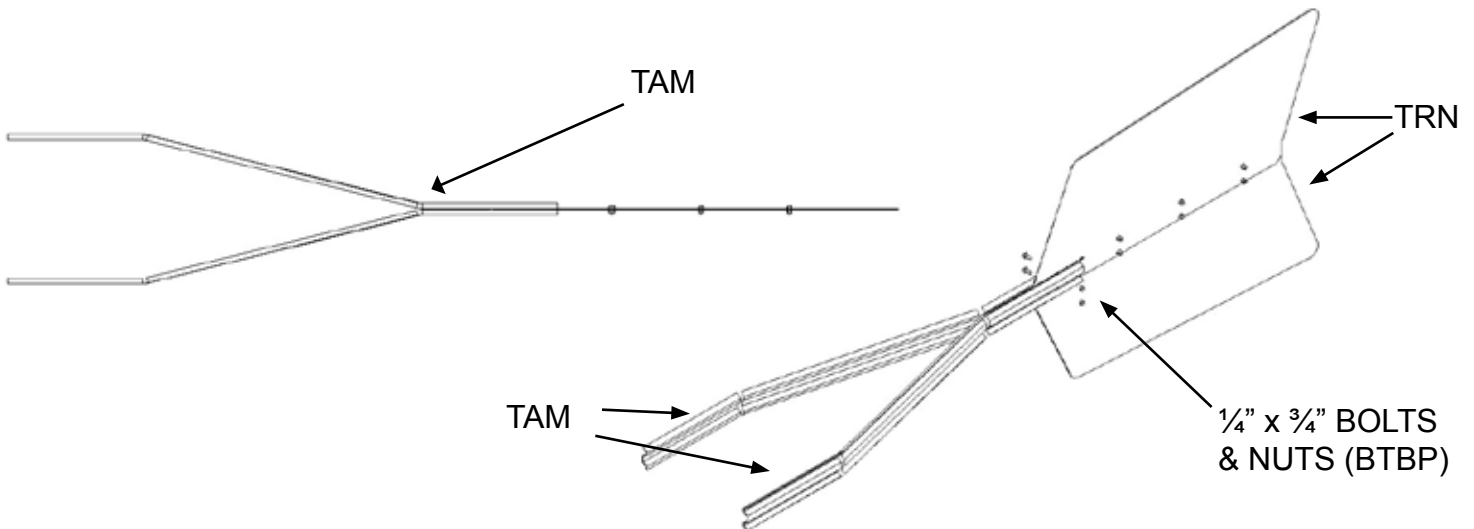

**STEP 11 — PIVOT TUBE and TAIL INSTALLATION:**

1. Insert the “U” bolt (package G) through the two holes in the back of the compressor and secure with  $5/16$ ” flange nuts (package B). Do not tighten tightly — leave loose until pivot tube has been installed.
2. Slip the pivot tube (PVT) (hole at the top of the tube) through the compressor bottom, through the “U” bolt clamp, and through the compressor top plate. Align the hole in the pivot tube to the compressor air line hose. Tighten the “U” bolt clamp with  $5/16$ ” nuts from inside the compressor until the pivot tube is held securely in place (see Illustration 7).
3. Install your pre-assembled tail arms and tail fins onto the compressor. The tail arms and tail fins are attached to the compressor body using  $5/16$ ” x  $1/2$ ” bolts (package A) and  $5/16$ ” flange nuts (package B). Note: Insert bolts from the outside and use nuts on the inside of the compressor housing. Tightening these nuts is done from the inside of the compressor, through the side opening (see Illustration 7). After these are tightened, replace the side cover plate.

Note: Cover plate will be very snug when sliding behind the tail arms. If too tight, slightly loosen the two bolts, insert side cover plate, then re-tighten the bolts.

Illustration 7

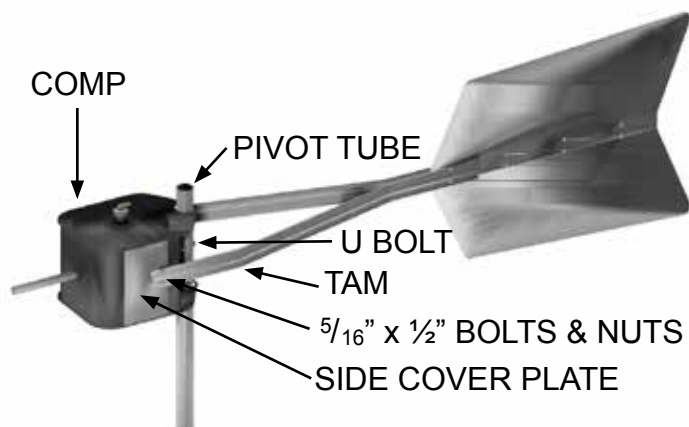

## STEP 12 — SETUP OF WINDMILL COMPONENTS:

### Setup of Windmill Components

1. Install the blade assembly onto the compressor crankshaft and tighten the Allen screws in locking collar with supplied  $\frac{5}{32}$ " Allen wrench (package G) on the flat sections of the crankshaft (photo 1). Note: A little lubricant on the crankshaft can help make this step easier. If needed, place the blade assembly on the ground and gently push down on the compressor to secure it into the two locking collars. Attach blade hub assembly (HUB) to the crankshaft using  $\frac{5}{16}$ " x  $\frac{1}{2}$ " bolt (package A) into the end of the shaft (photo 2). Make sure all Allen screws and the front mounting bolt are tight.
2. Install the dome (DOME) on the outside of the blade hub assembly (HUB). Secure with the four #10 x  $\frac{1}{2}$ " sheet-metal screws (package G) to blade hub assembly (HUB).

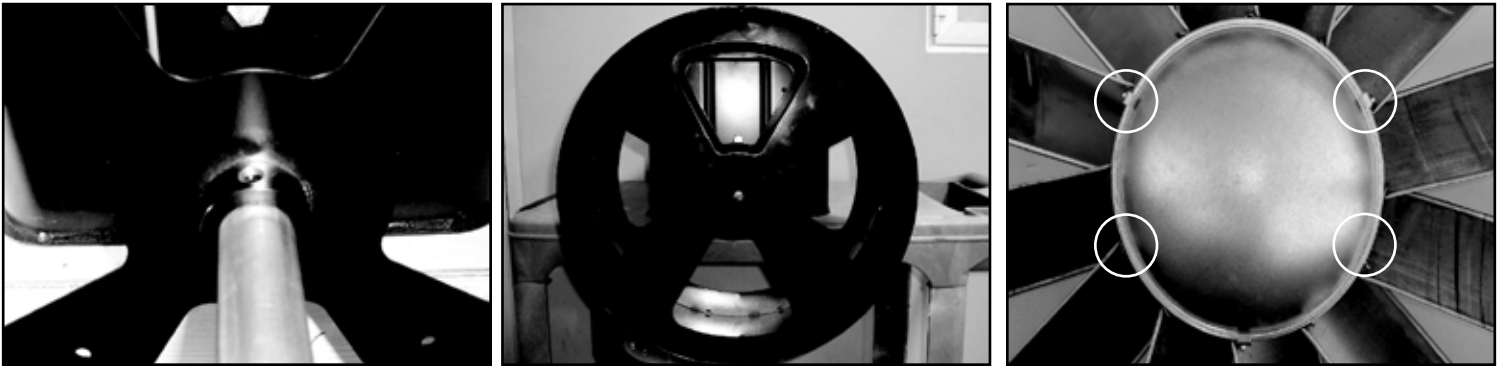

3. Install the completed rotor head unit onto the tower. Before you do this step, apply a thin coating of grease to the entire pivot tube and both sides of the pivot tube washer to aid in allowing the windmill head to turn as needed. With the tower being supported on a saw-horse or some type of stand, slide the pivot tube washer (PW) over the pivot tube. Then insert the pivot tube into the first plastic bushing in the top of the cone and continue through bottom bushing.
4. After the completed rotor head unit has been mounted at the top of the tower, insert the air line up through the tower (starting at the bottom and going out the top of the pivot tube). Put a small amount of grease onto each end of the  $\frac{1}{2}$ " x  $\frac{1}{2}$ " ninety-degree hose barb. Connect one end of the ninety-degree hose barb to the line running down the tower and to the pond. Push the air line back down and insert the ninety-degree hose barb through the  $\frac{9}{16}$ " hole in the pivot tube and into the  $\frac{1}{2}$ " air line connecting the compressor (see Illustration 8). A long-handled screwdriver or wrench can help leverage the hose barb into the  $\frac{1}{2}$ " connecting hose.
5. Insert the hose into the elongated hose bracket and air line clamp that was attached to the tower, just below the cone in the top 4' section. Tighten to secure the air line in the clamp. This allows the air line to spin on the hose barb and prevents kinking of the hose when the head spins.



6. After the previous procedures are done, stand up the completed unit on the site. Be sure to have enough people to hold the base of the tower and to help lift up the tower, or have your optional tower hinges in place. After the windmill has been erected, the ground rods can be driven into the ground through stake clamp brackets (SCBs), leaving 2"– 3" of the ground rods above the stake clamp brackets (SCBs). Level the windmill and tighten the clamps securely. For added high wind security it is **STRONGLY** recommended that you drill a 1/4" hole through the completed stake clamp and ground stake to accommodate a 1/4" bolt with lock washer and nut.
7. Please note: Anchoring of Outside Water Solutions Windmill Towers. Outdoor Water Solutions, Inc. will not determine soil and wind conditions for any windmill erection. Therefore, these conditions must be determined by the customer. Anchoring of the windmill tower is very important. It is the customer's responsibility to adequately anchor the tower. Outdoor Water Solutions, Inc. supplies a basic anchoring kit with each unit. However, we strongly recommend the use of concrete pilings, a concrete pad, or screw-in anchors. High winds or light soil conditions can cause the windmill to fall over, physically damaging the rotor head and other components. The customer is responsible for anchoring the windmill adequately or consulting the appropriate people to do so.

Illustration 8

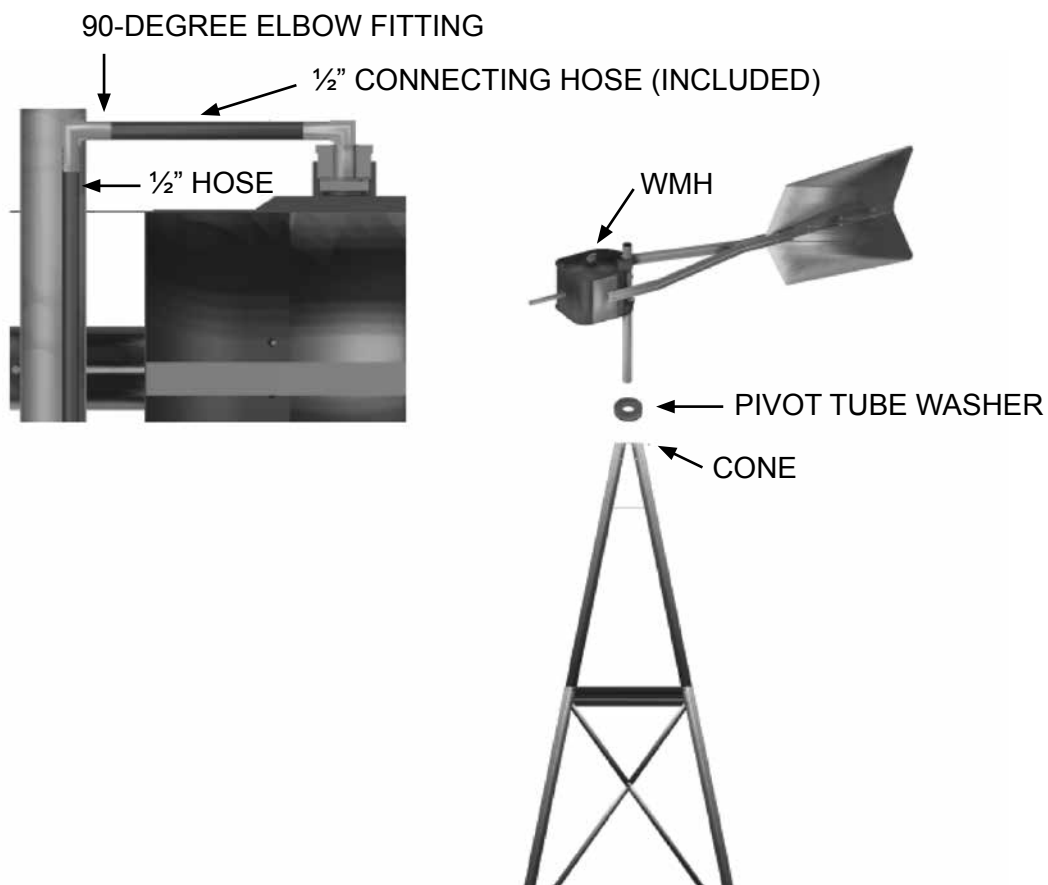

## Instructions for Placing Airstone in Pond

We recommend that you put your airstone into a rubber or plastic bucket to help protect it from the mud and debris common in the bottom of most ponds. A 3”– 5” layer of small rock, sand, or even concrete put into the bottom of the bucket can help weigh the bucket down, so that it sits on the bottom.

We also suggest installing the airstone into the deep part of the pond to ensure complete circulation of your water. The exception to this would be that, if you want to keep the water open for watering livestock in the winter, then you can put the stone closer to the shoreline (or move it there in the fall). You can also place the airstone in a shallow area, if you are in a northern climate and have trout, walleye, Northern pike, or muskie in the pond or lake and want the deep parts of the pond to remain colder in the summer months.

The use of OWS Weighted Air Line will help keep the air line submerged and on the bottom of the pond. In the absence of using weighted air line, we recommend tying rebar, bricks, blocks, etc. to the non-weighted air line to help keep it submerged.

If you are attaching multiple airstones, then an OWS 2-way selector valve is needed. These are available in combinations and are made up of high-quality brass-ball valves that allow you to adjust and regulate the airflow between multiple accessories.

Note: Air will travel to the point of least resistance or to the shallow airstones first. Adjusting the airflow, so that it goes to the deeper airstones, is usually required.

**CONGRATULATIONS!!!**

We hope your new Outdoor Water Solutions Windmill will give you many years of joy!

### OWS Pond Pack

A complete kit of all-natural products that will jump-start your pond and help keep it clean for the whole season. Each kit is designed to treat ¼ acre of water and includes 10 lbs. of a water clarifier; 12 lbs. of bacteria in a barley-straw medium, packaged in water-soluble pouches, and 2 lake & pond dye packs – all of which are safe to fish! Multiple kits should be used for larger-size ponds. Products help break down organic matter, diminish nutrient overload, and help reduce odor to create a clean, clear pond without having to use commercial algacides and chemicals. All products are packed dry for ease of handling and less risk of spillage. Made in the USA.



Item # PSP0001 (23 lbs.)

### OWS Lake & Pond Muck Pellets

This is a new, highly concentrated product designed to clean up areas of muck around a pond, swimming area, or dock. Contains sludge-eating bacteria, which allows you to focus on problem areas with a self-sinking, highly concentrated bacteria blend, designed to break down the muck and sludge in a specific area.



- Item # PSP0153 1 lb. Trial Size
- Item # PSP0150 10 lbs. Pail
- Item # PSP0151 25 lbs. Pail (value-priced)



### All-Natural Blue Pond Dye

If you're looking for a highly concentrated liquid blue dye for your ponds, we've got it! This product is equivalent to other companies' ONE Gallon containers and is 4X Concentrated! Pond Dye helps prevent weeds and algae from growing by naturally blocking out the sun's harmful UV rays. A "must-have" to naturally keep your pond weed-free, and also to add an attractive blue color to your pond. Contains highly concentrated Acid Blue #9, which is safe for recreational ponds, horses, cattle, birds, fish, wildlife, and the environment.

Item # PSP0125 (3 lbs.)

### OWS Lake & Pond Bacteria

Each pack includes 12 lbs. of bacteria in a barley-straw medium, packaged in water-soluble pouches. Our bacteria help break down organic matter, diminish nutrient overload, and help reduce odor to help create a clean, clear pond.



- Item # PSP0074 (12 lbs.)
- Item # PSP0132 (25 lbs.)

### OWS Lake & Pond Dye

A high-quality proprietary blend of environmentally friendly, non-toxic, water-soluble dyes that are formulated to help maintain your pond or lake by filtering sunlight and adding an aesthetically pleasing blue color. Each packet treats a ¼-acre pond and is packed dry in a water-soluble pouch for ease of handling and less risk of spillage. Purchase multiple packs for larger bodies of water.



- Item # PSP0002 (.375 lbs.)
- Item # PSP0196 Twin Pack (.75 lbs.)

## OWS Fish & Game Feeder

### OWS Fish & Game Feeder

Manage a better pond and grow bigger, healthier fish with the Outdoor Water Solutions fish feeder. If you're looking for accurate feeding, less waste and larger healthier fish, then this is the feeder for you.

#### Features include:

- One base for both dock and shore mounting
- Base tilts 45° for optimal feeding even on steep pond banks
- Base also swivels 180° to put the feed exactly where you want it
- Single stage motor for simplicity
- Includes 5 watt commercial grade solar panel and rechargeable battery
- Solar panel mounts on top for optimal sunlight and won't break off
- 10 year warranty on the camo finish, 5 years on the timer and 2 years on timer
- Feeds up to 5/16" fish feed
- Holds up to 100 lbs. of fish food
- Welded interlocking top that won't leak



Item # FDR0482 (41 lbs.)

